

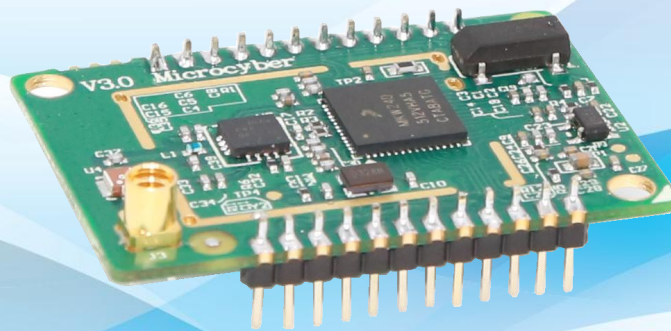

MICROCYBER

User Manual of M1100S *WirelessHART* Module



Microcyber Corporation



FIELD COMM GROUP™
Connecting the World of
Process Automation



HART
COMMUNICATION PROTOCOL



CERTIFICATE OF MEMBERSHIP

The Board of Directors hereby acknowledges that

Microcyber Corporation

has accepted and fulfilled the requirements of the Bylaws
and all rights and privileges of membership are hereby granted

Membership Term: November 2019 – October 2020

J. G. Mastus

President and CEO



Table of Contents

1.1	<i>Wireless</i> HART Network Overview.....	3
1.2	Summary of M1100S <i>Wireless</i> HART Module.....	3
1.3	Terms and Abbreviations.....	4
1.4	Reference Specifications.....	4
2	M1100S Module Composition and Overall Framework.....	5
3	Mechanical and Electrical Specifications.....	5
3.1	Mechanical Specifications.....	5
3.2	Pin Assignment.....	5
3.3	Electrical Specifications.....	6
4	Communication Mechanism and Message Format between WHM and Instrument Board.....	7
4.1	Communication.....	7
4.2	Data Frame Format.....	8
4.3	Initialization Phase.....	11
4.4	Operational Phase.....	11
4.5	<i>Wireless</i> HART Network Request.....	11
4.6	Maintenance Interface.....	13
4.7	Intra-system Communication.....	13
5	Information Synchronization of M1100S Module and Instrument Board.....	14
5.1	Device Status.....	14
5.1.1	General Structure.....	14
5.1.2	Issuing an Indication – Command #64520.....	15
5.1.3	Reception of an Indication – Command #64518.....	16
5.1.4	Creating Current Status Information and Changed Counter Value.....	16
5.2	<i>Wireless</i> HART Join Status.....	16
6	Burst Mode.....	17
7	Annex A.....	18
8	Annex B.....	20

Summary

1.1 *WirelessHART* Network Overview

WirelessHART standard is developed together by HCF member companies, main wireless device manufacturers and industrial users under the guidance of the HART Communication Foundation (HCF). *WirelessHART* is a wireless mesh network communications protocol, specially designed for process automation application.

WirelessHART adopts mesh topology network technology, safe and stable with 2.4 GHz ISM frequency band, and all the information is packaged in one packet, to realize data transmit through DSSS (Direct Sequence Spread Spectrum) and FHSS (Frequency Hopping Spread Spectrum) technology based on IEEE802.15.4. A *WirelessHART* network consists of three key elements: *WirelessHART* field devices, *WirelessHART* gateway and *WirelessHART* network manager, also supports *WirelessHART* adapter, to let existing HART devices access *WirelessHART* network, and supports *WirelessHART* handheld devices, to connect adjacent *WirelessHART* devices. Figure 1.1 shows the complete *WirelessHART* network structure.

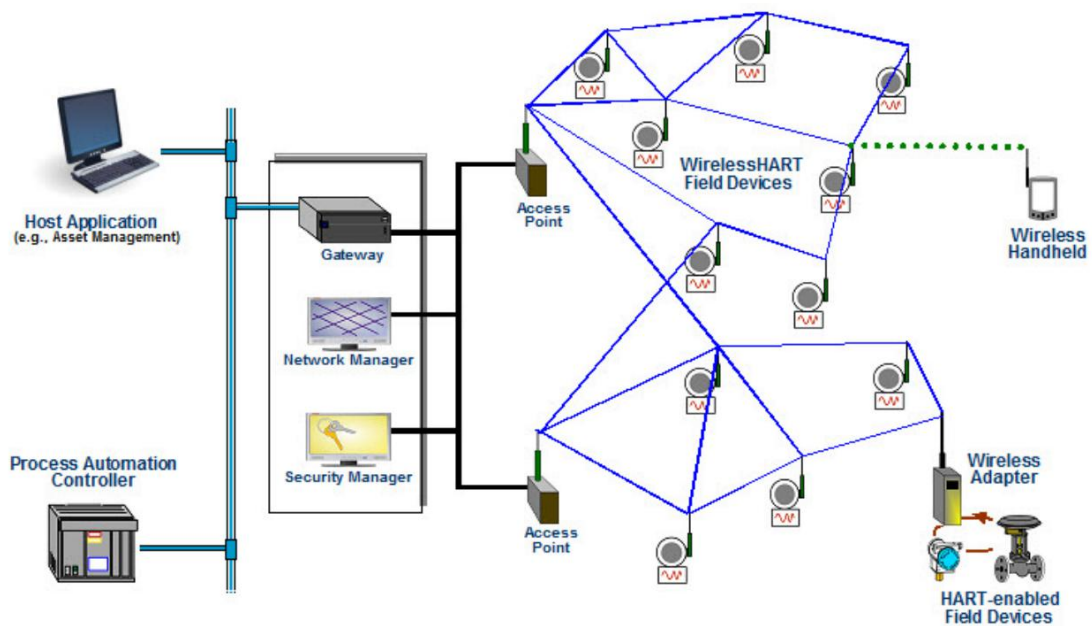

Figure 1.1 *WirelessHART* Network Structure

1.2 Summary of M1100S *WirelessHART* Module

M1100S *WirelessHART* module is a wireless communication module compliant with HART7.4 protocol, and is the core part of *WirelessHART* field device, as shown in Figure 1.2. M1100S periphery provides TTL serial port and control interface. Through the serial port, the M1100S communicates with special customized instrument board, to combine a complete *WirelessHART* field device. The control interface is used to control input and output of the serial port. M1100S supports all the mandatory commands of fieldbus device in HART7.5 protocol and Burst mode.

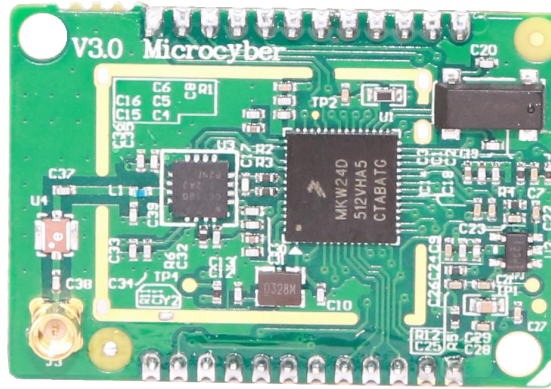

Figure 1.2 M1100S Module Photo

1.3 Terms and Abbreviations

WirelessHART

M1100S

HCF

DSSS

FHSS

Delimiter

Address

Command

Payloadlength

Payload

Checksum

STX

ACK

Burst

MasterAddress

SlaveAddress

device status

extended device status

standardized status 3

configuration changed counter

Device malfunction

Configuration changed

Cold start

More status available

Loop current fixed

Loop current saturated

Non-primary variable out of limits

Primary variable out of limits

WirelessHART Module

HART Communication Foundation

Direct Sequence Spread Spectrum

Frequency Hopping Spread Spectrum

Delimiter

Address

Transmission Frame Start

Acknowledgement

Active Data Transmission Mode

1.4 Reference Specifications

Wireless Command Specification – HCF_SPEC-155 v2.0

HART Field Communication Protocol Specification – HCF_SPEC-13 v7.4

Command Summary Specification– HCF_SPEC-99 v9.0

Command Tables Specification–HCF_SPEC-183 v23.0

2 M1100S Module Composition and Overall Framework

Serial port communication mode is used between M1100S module and instrument board, with half-duplex communication mechanism, to complete information interaction between the instrument board and M1100S module. Instrument board provides maintenance port to realize parameter configuration of M1100S module, process monitoring, and other functions. Typical application scenarios of M1100S module are shown in Figure 2.1 below.

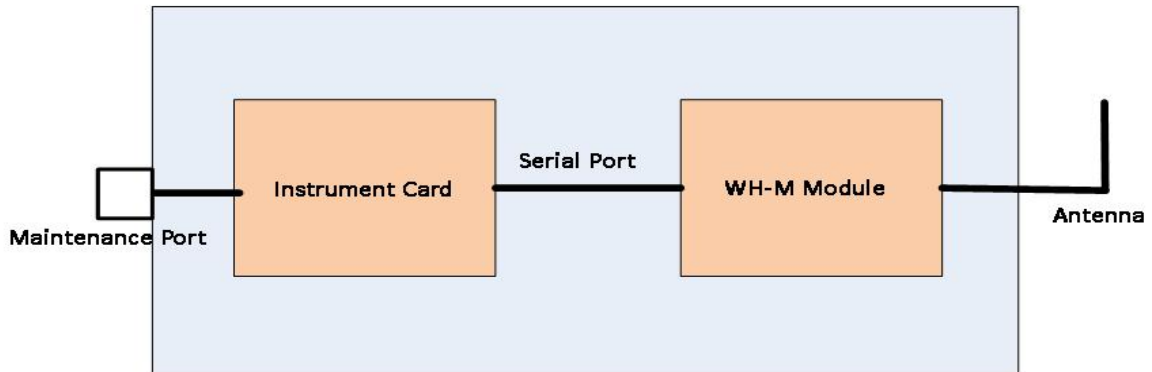

Figure 2.1 M1100S Typical Application Framework

3 Mechanical and Electrical Specifications

3.1 Mechanical Specifications

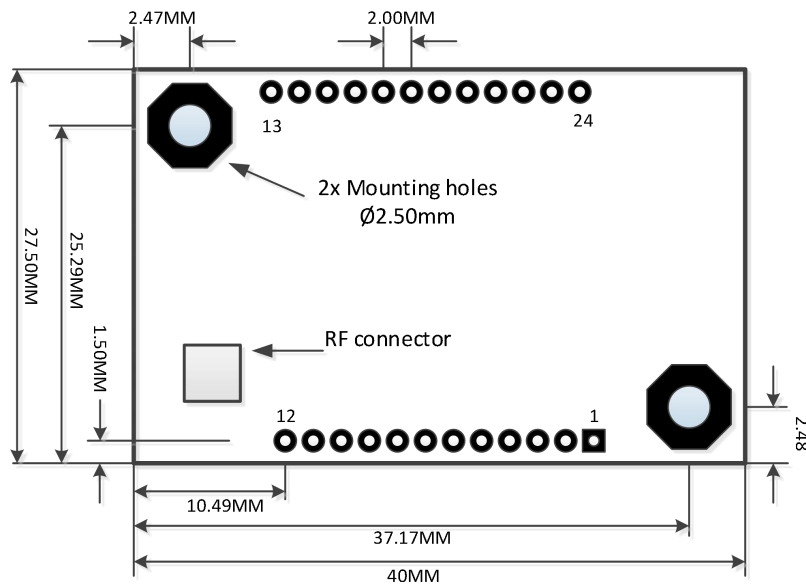

Figure 3.1 Mechanical Dimensions of the M1100S Module

3.2 Pin Assignment

Mark	Name	Direction	Description
1	GND	In	Power Groud
2	VCC	In	Power Supply +
3	RESERVED	-	Do not connect



4	RESERVED	-	Do not connect
5	RESERVED	-	Do not connect
6	RST	In	Module Reset Pin
7	RESERVED	-	Do not connect
8	RESERVED	-	Do not connect
9	RESERVED	-	Do not connect
10	RESERVED	-	Do not connect
11	RESERVED	-	Do not connect
12	RESERVED	-	Do not connect
13	TXD	Out	Data output of serial 1
14	RXD	In	Data input of serial 1
15	CD	Out	Indicating module data sending. Low level is valid.
16	RESERVED	-	Do not connect
17	RTS	In	Indicating instrument card request data sending. Low level is valid.
18	RESERVED	-	Do not connect
19	RESERVED	-	Do not connect
20	RESERVED	-	Do not connect
21	RESERVED	-	Do not connect
22	RESERVED	-	Do not connect
23	RESERVED	-	Do not connect
24	RESERVED	-	Do not connect

3.3 Electrical Specifications

Operating Conditions	
Supply Voltage	2.7V - 3.3V
Operating Temperature	-40°C - +85°C
Relative Humidity	<90%
Current Consumption	
Transmitting Current	53mA(10dBm)
Receiving Current	33mA
Sleep Current	10uA
Digital IO	
V _{IH}	0.7*V _{cc}
V _{IL}	0 - 0.3*V _{cc}
V _{OH}	0.8*V _{cc}
V _{OL}	0 - 0.2*V _{cc}
RF Characteristics	
Frequency Band	2.4GHz - 2.48GHz



Number of Channels	15
Channel Separation	5MHz
Occupied Bandwidth	2.7MHz
Transmission Rate	250Kbps
Receiver Sensitivity	-102dBm
Output Power	10dBm
Output Impedance	50Ω
Frequency Accuracy	-40ppm - 40ppm

4 Communication Mechanism and Message Format between WHM and Instrument Board

4.1 Communication

The user instrument board is connected with module through a standard TTL serial port (UART) and two control lines.

Figure 4. 1 Serial port Setting

Baud rate	9600
Start bit	1
Data byte	8
check	even-parity
Stop bit	1

Module User interface in detail:

TXD: Serial data output port. *WirelessHART* module uses it to transmit data to instrument board.

RXD: Serial data input port, which is used by instrument board to send data to *WirelessHART* module.

RTS: Indicating instrument board's request for sending data. Low level is valid. Before instrument board sends data to module, it is requested to pull down the port signal until the data is sent out. Since the M1100S may be in a deep sleep mode, the RTS must be pulled down t_{pre} of before instrument board sends data. (See Figure 4.1).

CD: Indicating M1100S's request for sending data. Low level is valid. The M1100S uses the port to indicate that it will send data to instrument board. If no data is transmitted, CD will maintain the high level. Before the M1100S sends data to instrument board, it pulls the port signal low and keeps it low until all data is transmitted. M1100S starts to transmit preambles immediately after pulling CD low.

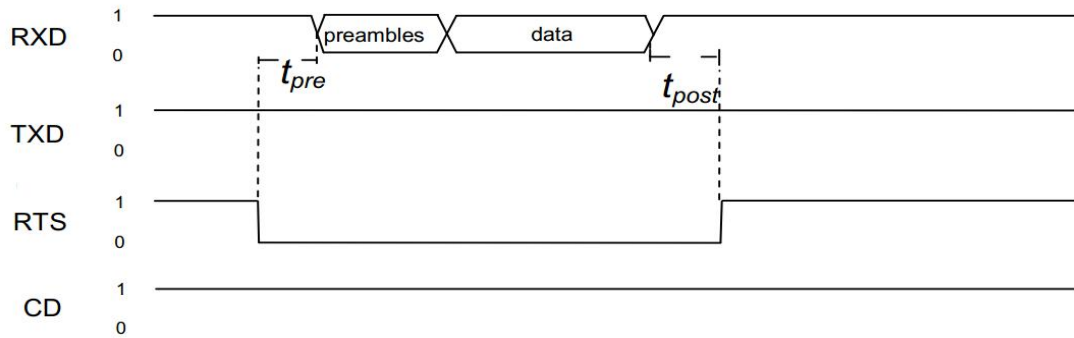

Figure 4.2 Sequence Chart for Instrument Board Sending Data

Figure 4.2 is sequence chart for instrument card sending data to *WirelessHART* M1100S. 0xFF is used as preambles. There must follow at least two preambles after pulling down t_{pre} of RTS.

$$t_{pre}=4\text{ms}$$

$$t_{char}=1.15\text{ms}$$

$$t_{post}\geq 0\mu\text{s}(\text{RTS inactive after last bit.})$$

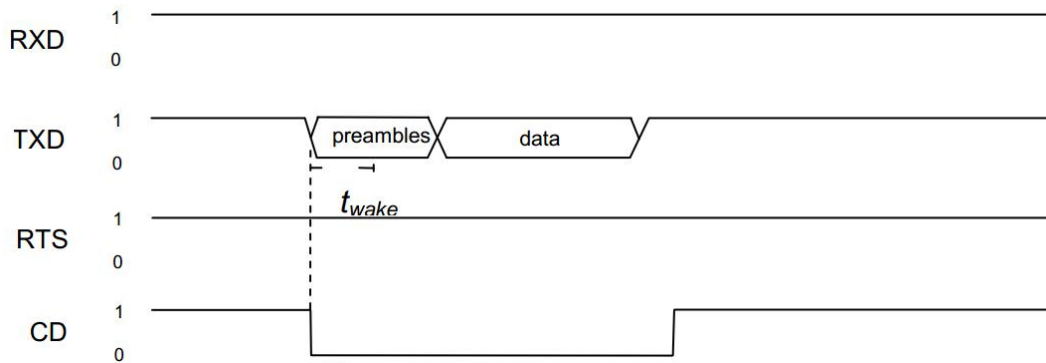

Figure 4.3 Sequence Chart for *WirelessHART* Module Sending Data

Figure 4.3 is sequence chart for *WirelessHART* module sending data to instrument board. The M1100S starts to transmit preambles immediately after it pulls down the CD signal. The default number of preambles sent is 6. Assumed the instrument board requires at least two correct preambles, it has t_{wake} time to be ready for reception after CD signal is pulled low.

A valid communication includes request and response. Both instrument board and M1100S can act as master and shall be able to act as slave. To every request there always must be a response. Transmission of the response must be within 32ms after receipt of a request. If no response is received by the requester within 32ms, the requester may send the request again. The M1100S does retry up to 3 times. At the same time, to avoid conflict, continuous request is not allowed be sent in a period of 4.5s after the reception of a response.

4.2 Data Frame Format

UART serial port is used between M1100S and instrument board.

Data format definition between instrument board and M1100S module is shown in Figure 4.4

Delimiter (1 byte)	Address (1/5 byte)	Command (1 byte)	Payload Length (1 byte)	Payload (0-90 byte)	Check (1 byte)
-----------------------	-----------------------	---------------------	----------------------------	------------------------	-------------------

Figure 4.4 Data Frame Format

Delimiter is defined as 1 byte. Its value describes the data frames type and selected address. Table 4.1 lists all delimiters related with the interface and their meaning.

Table 4.1 List of Delimiters

Delimiter	Description
0x02	STX using poll (short) address: HART request during initialization phase
0x82	STX using long address: HART request
0x06	ACK using poll (short) address: HART response during initialization phase
0x86	ACK using long address: HART response

Address part is divided into long address and short address according to different delimiters. Long address is 5 bytes and short address is 1 byte. Figure 4.5 is the address forms.

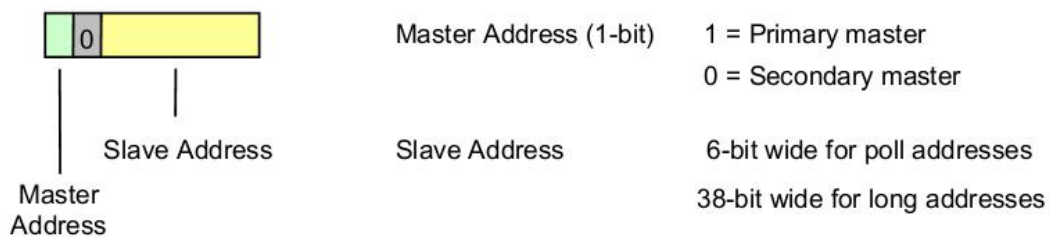

Figure 4.5 Address Format

MasterAddress identifies the peer which sends the request. SlaveAddress identifies the peer which receives the request and sends response. 6-bit short address can take values between 0-63. 38-bit long address consists of a unique DeviceID and the extended device type (see HART specification for details).

The M1100S always acts as primary master and instrument board shall be secondary master. When address type is short address, instrument board uses 0 as SlaveAddress, and M1100S uses 15. The long address of M1100S is 0x00000000.

Response uses the same address field as the request. Example: The M1100S sends a request to the instrument board and uses short address. The address field of the request's data frame is 0x80 (primary master and slave address 0). When the instrument board responds, the address field does not change and is 0x80 too.

The command field is 8-bit wide and contains the HART command supported by M1100S. If the command number is higher than 255, the command field will be occupied by Command 31; then the 16-bit command number is part of the payload, to place HART command.

Payload length is 8-bit wide and is equal to the number of bytes contained in the payload, i.e. the number of bytes between the payload length field and the checksum. Payload length field and checksum are not included.

The checksum field is 8-bit wide. It is calculated by XOR'ing all data before the checksum.

Payload data can be up to 90 byte, and commands lower or equal 255. In Figure 4.6, the payload data format for commands is depicted.

- a) Request payload;
- b) Normal response data format;
- c) Command error response payload;
- d) Communication error response payload.

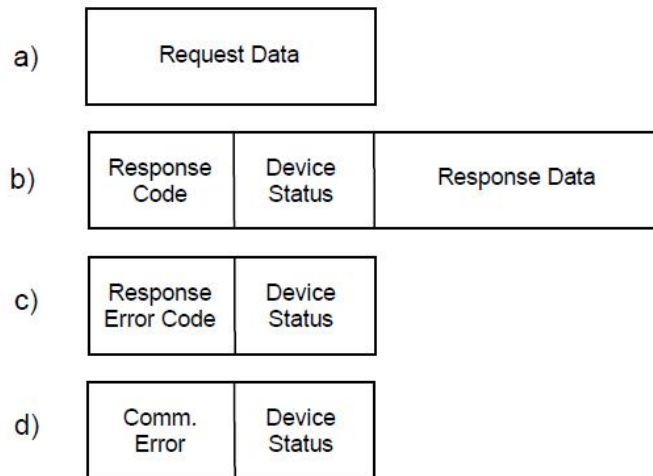

Figure 4.6 Commands Lower or Equal 255

Expansion command will be used if commands are higher than 255. If the communication error response is the same with response of commands lower than 255, it won't be shown in the figure below. In Figure 4.7, the format of the request and response payload with expansion command is shown.

- a) Request payload;
- b) Normal response payload;
- c) Command error response payload

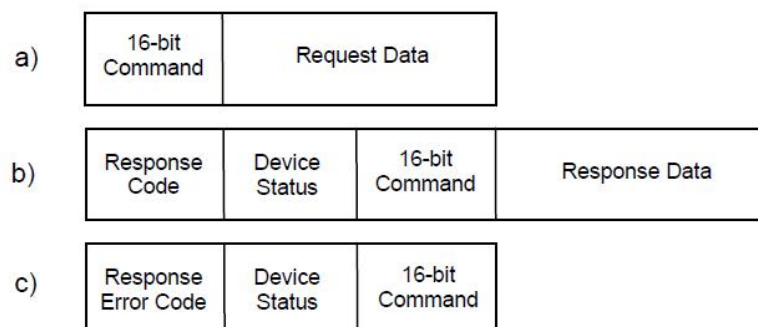



Figure 4.7 Commands Higher than 255

4.3 Initialization Phase

After start-up the M1100S is in its initialization phase. When the internal initialization is completed the M1100S starts to periodically send HART command #0 requests to the instrument board until it receives a response. The request is sent to polling address 0. As soon as the instrument board is ready for operation it shall answer the request with a valid response. The response contains all information required to form the long address of the field device. As soon as the M1100S receives the response, initialization phase is completed and normal operation mode is entered. To compliant with HART specification, the M1100S uses the long address for all requests after the initialization phase.

4.4 Operational Phase

After the initialization phase, the system is in the operational phase. During the normal operational phase, there are three reasons for communication between the M1100S and the instrument board:

1. HART command request from the *WirelessHART* gateway or network manager
2. Maintenance port usage
3. Intra-system communication to synchronize information base and device status

4.5 *WirelessHART* Network Request

In normal operation, a *WirelessHART* field device receives HART command requests from the *WirelessHART* gateway or network manager. This is besides autonomous publishing of process values the most common type of wireless network communication. Whenever a request is received by the M1100S, it has to be decided whether the command is processed by the M1100S itself or if it has to be processed by the instrument board.

Table 4.2 Standard HART Commands Supported by the M1100S

HART Commands	Description
103	Write burst period
104	Write burst trigger
105	Read burst mode configuration
107	Write burst device variables
108	Write burst mode command number
109	Burst mode control
115	Read event notification
116	Write event notification bit mask
117	Write event notification timing
118	Event notification control
119	Event acknowledge
768-976	All mandatory wireless commands



Table 4.2 lists all commands supported by the M1100S directly. In general all *WirelessHART* commands (see HCF_SPEC-155Revision2.0 for details) and all burst mode commands are supported. The instrument board does not get any notice of those commands processed by the M1100S. All other commands which are not supported by the M1100S are forwarded to the instrument board.

WirelessHART devices must support some HART mandatory commands. All mandatory commands which are not already supported by the M1100S must be implemented by the instrument board. The required commands are listed in Table 4.3 below.

Table 4.3 Mandatory HART commands

HART command	Description
0	Read Unique Identifier
1	Read Primary Variable
2	Read Loop Current and Percent of Range
3	Read Dynamic Variables and Loop Current
6	Write Polling Address
7	Read Loop Configuration
8	Read Dynamic Variable Classification
9	Read Device Variables with Status
11	Read Unique Identifier Associated with Tag
12	Read Message
13	Read Tag, Descriptor, Date
14	Read Primary Variable Transducer Information
15	Read Device Information
16	Read Final Assembly Number
17	Write Message
18	Write Tag, Descriptor, Date
19	Write Final Assembly Number
20	Read Long Tag
21	Read Unique Identifier Associated with Long Tag
22	Write Long Tag
38	Reset Configuration Changed Flag
41	Perform Self Test
42	Perform Device Reset
48	Reset Additional Device Status
54	Read Device Variable Information
59	Write Number of Response Preambles
78	Read Aggregated Commands
79	Write Device Variable
90	Read Real-Time Clock
106	Flush Delayed Response Buffers



4.6 Maintenance Interface

All *WirelessHART* field devices must provide a maintenance Interface. The maintenance Interface can either be a standard HART process interface or a dedicated maintenance Interface. The M1100S does not provide a maintenance Interface thus it is the responsibility of the instrument board to provide one.

The maintenance Interface is used for configuration purposes and therefore is also used to configure burst mode and especially to setup network configuration which is required to connect to the network. The instrument board forwards all commands to the M1100S via the maintenance interface.

4.7 Intra-system Communication

Intra-system communication, i.e. communication between the M1100S and the instrument board which is not triggered by the *WirelessHART* network or the maintenance interface, can be used to exchange device status and configuration data. Example: The *WirelessHART* device is showing the *WirelessHART* network tag in a LCD. The display is controlled by the instrument board. To get the current network tag the instrument board sends a command #776 request to the M1100S and receives the current tag with the response.

Additionally to all standard HART commands listed in Table 4.3, the M1100S implements a number of specific commands which provides additional information and functionality. Some commands should only be used for intra-system communication and are not allowed for requests from the maintenance interface. It is the instrument board responsibility to filter those requests and not forward them through *WirelessHART* network. A list of the device specific commands and their restriction is found in the Table 4.4 below. The complete description can be found in Annex A.

Table 4.4 M1100S specific HART commands

HART command	Description
64525	Write <i>WirelessHART</i> power settings [restricted]
64530	Set/clear Write Protect [restricted]
64531	Read Write Protect [restricted]
64600	Read diagnostic information[restricted]

Another important use for intra-system communication is status synchronization between the instrument board and the M1100S. Table 4.5 lists the HART commands which may be sent to the instrument board by the M1100S. It is recommended that the instrument board can process these. A complete description of the commands can be found in Annex B.

Table 4.5 Recommended Commands to be Supported by the Instrument Board

HART command	Description
64518	Status change indication
64519	<i>WirelessHART</i> connection indication



5 Information Synchronization of M1100S Module and Instrument Board

5.1 Device Status

Status synchronization between the M1100S and the instrument board is realized by HART indication requests (HART commands 64518/64520). Indication requests are sent from the M1100S to the instrument board and vice versa. The M1100S uses command 64518 to issue a status change indication and the instrument board uses command 64520 to issue status update signal. Even though the command numbers are not the same, both commands are constructed in the same way. The request data contains the status of the current device and the response contains the status of the destination device. Every time an internal status change occurs, the M1100S issues a configuration changed command to the instrument board. M1100S keeps an internal mirror of the instrument board's status variables and combines these statuses whenever it is required. The instrument board should also mirror all status variables of the M1100S and create the current state out of these values and the internal status variables (status variables should be OR'ed together. Configuration changed counters should be added).

Status which must be synchronized:

- Device status (see HCF_SPEC-099 Revision 9.0, Field Device Status)
- Extended device status (see HCF_SPEC-183 Revision 20.0, Common Table 17)
- Standardized status 3 (see Common Table 32)
- Configuration changed counter (16bit)

5.1.1 General Structure

The instrument board should keep a copy of both its internal state and the M1100S's status. An example of structure of all local and remote variables is shown below:

```
typedef struct
{
    uint8_t    localDeviceStatusCommon;
    uint8_t    localDeviceStatus[MAX_NUMBER_OF_MASTERS];
    uint8_t    localExtendedStatus;
    uint8_t    localStandardizedStatus3;
    uint16_t   localConfigChangedCounter;
    uint8_t    remoteDeviceStatusCommon;
    uint8_t    remoteExtendedStatus;
    uint8_t    remoteStandardizedStatus3;
    uint16_t   remoteConfigChangedCounter;
}T_STATUS_DATA;
```

The localDeviceStatusCommon/remoteDeviceStatusCommon variables contain all status bits except the cold start and configuration changed bit:

0x80 Device malfunction



- 0x40 **NOT SET** (Configuration changed)
- 0x20 **NOT SET** (Cold start)
- 0x10 More status available
- 0x08 Loop current fixed
- 0x04 Loop current saturated
- 0x02 Non-primary variable out of limits
- 0x01 Primary variable out of limits

The localDeviceStatus field provides two flags for every connected master. The two flags are not contained in the localDeviceStatusCommon variable. They are the cold start and the configuration changed flag which can be set in two ways below:

- Local event (cold start or configuration changed event)
- Incoming trigger via indication command

They can only be reset by a particular master via incoming commands from that master and also for this master only. The first incoming command from a particular master resets the cold start flag. Command 38 (reset configuration changed flag) is used to reset the config changed flag.

5.1.2 Issuing an Indication – Command #64520

Whenever any of the internal status variables changes, a status changed indication (command 64520 request) must be sent to the M1100S with the current values (for detailed command description see B.3). This for example applies to configuration changes (e.g. command 17 – write message) or if the instrument board sets a status bit (e.g. Device malfunction, more status available).

Changes which concern every master (attached to either the wired or wireless part) are handled in a special way, these are:

- Configuration changed
- Cold start

These flags are ignored in the device status byte of command 64520, but they are transmitted in an extra field (byte 5 of cmd 64520, see command description of cmd 64520). During a cold start or configuration changed event, the instrument board sets the corresponding flag byte and issues the indication once. The state of the flag byte is not repeated, it's just a trigger and only issued once. If anyhow the packet gets lost, the M1100S will miss the trigger and not set its master flags accordingly. This is not completely correct but it's also not that important and the configuration changed counter is consistent anyway.

Each status variable or status flag which is not used or known by the instrument card itself must be set to 0. The M1100S will also OR remote and local values together and if remote flags are not set, its internal state will be used.



5.1.3 Reception of an Indication – Command #64518

Each time the instrument card receives a command 64518 indication request from the M1100S module, it must update the status values of remote device (M1100S module) and answer its local status values in the response (for detailed command description see B.1).

The received remote values shall update the local mirrors (by overwriting old values). These values are:

- Device status
- Extended device status
- Standardized status 3
- Configuration changed counter

According to the flags set in byte 5 of the request, the instrument card must set the corresponding flags of all of its master in the localDeviceStatus array (e.g. if cold start flag is triggered, the instrument card must set the cold start bit in localDeviceStatus for each master).

The instrument board shall use its internal status values to craft together the cmd 64518 response. But it must not repeat the cold start/configuration changed triggers of the M1100S when there was no local event in the meantime, too.

5.1.4 Creating Current Status Information and Changed Counter Value

The current status variables are a combination (OR'ed together) of both the local and the remote variables plus specific flags:

```
deviceStatus = localDeviceStatusCommon | localDeviceStatus[masterId] |  
              remoteDeviceStatusCommon
```

The same applies to all other status variables with one exception that there is no master-specific status for these variables (extended device status, standardized status 3):

```
statusVariable = localStatus | remoteStatus
```

The actual configuration changed counter is just the sum of both the local and the remote value:

```
configChangedCounter = localConfigChangedCounter + remoteConfigChangedCounter
```

5.2 WirelessHART Join Status

Every time the actual join status of the *WirelessHART* stack changes (e.g. from *operational* to *disconnected*, a *WirelessHART* connection indication is sent to the instrument board). The connection indication is a HART command #64519 request containing the current wireless operation mode (see Annex A).



6 Burst Mode

Event notifications and burst messages are natively supported by the M1100S burst mode functionality. They are only supported on the *WirelessHART* network (TDMA data link layer) since the M1100S itself does not have a wired HART interface. All commands related to burst mode and event notifications are processed by the M1100S.

Burst message contains commands #1, #2, #3, #9, #33, #48 or specific commands published to the *WirelessHART* gateway periodically. The HART command responses are updated by the M1100S automatically, i.e. the M1100S transmits command request to the instrument board periodically and sends HART command response from the instrument board. The update rate is equal to the minimum update period configured for the burst message.

The requests for updating the universal commands issued by the M1100S are determined by the burst message configuration. Device specific command update requests do not have any payload.

Event notifications require monitoring of the complete device status. The M1100S periodically requests updates of command #48 from the instrument card. The update rate is half the de-bounce period configured for the event notification.

The complete timing and publishing of the burst messages and event notifications is done by the burst mode implementation of the M1100S.

7 Annex A

A.1 HART Command #64525: Write *WirelessHART* Power Settings

Write *WirelessHART* power settings which are used in command #777 and #778.

Request

Byte	Format	Description
0	uint8_t	Power source (see HART common table 44)
1-4	time	Duration at peak packet load before power drain (set to 24 h if not applicable).
5-8	time	Time to recover from power drain (set to zero if not applicable).
9-10	unit16_t	Battery life remaining in days

Response

Byte	Format	Description
0	uint8_t	Power source (see HART common table 44)
1-4	time	Duration at peak packet load before power drain (set to 24 h if not applicable).
5-8	time	Time to recover from power drain (set to zero if not applicable).
9-10	unit16_t	Battery life remaining in days

Response code

Code	Class	Description
0	Success	No command-specific errors
1-127		Undefined

A.2 HART Command #64530: Set/Clear Write Protect

Set or clear write protect flag of the M1100S.

Request

Byte	Format	Description
0	uint8_t	Switch write protect on (=1) or off (=0).

Response

Byte	Format	Description
0	uint8_t	Current write protect state: on (=1) or off (=0).

Response code

Code	Class	Description
0	Success	No command-specific errors.
1		Undefined



2	Error	Invalid selection
3-4		Undefined
5	Error	Too few data bytes received.
6-127		Undefined

A.3 HART Command #64531: Read Write Protect State Request

Request

Byte	Format	Description
-	-	-

Response

Byte	Format	Description
0	uint8_t	Current write protect state: on (=1) or off (=0).

Response Code

Code	Class	Description
0	Success	No command-specific errors
1-127		Undefined

A.4 HART Command #64600: Read Diagnostic Information

Currently only support read receive signal level.

Request

Byte	Format	Description
0	uint8_t	Diagnostic parameter id: =5 - Read link quality

Response

Byte	Format	Description
0	uint8_t	Diagnostic parameter: id: =5
1-2	uint16_t	Average receive signal level in dBm

Response code

Code	Class	Description
0	Success	No command-specific errors
1		Undefined
2	Error	Invalid selection.
3-4		Undefined
5	Error	Too few data bytes received
6-127		Undefined

8 Annex B

B.1 HART Command #64518: Status Change Indication (M1100S to Instrument Board)

Device status, extended device status, configuration change counter and standardized status 3 of the M1100S are indicated to the instrument board whenever they change. The instrument board will synchronize to the status by setting its internal device status accordingly.

Request

Byte	Format	Description
0	uint8_t	Device status (without cold start and configuration changed flags)
1	uint8_t	Extended device status
2	uint8_t	Standardized status 3
3-4	uint16_t	Configuration changed counter
5	uint8_t	Configuration changed and cold start flags -0x01 cold start -0x02 configuration changed The flags contained in this field shall only be triggered once when a particular event occurs. They are used to set the according master flags on the other side, but they are not reset if the next indication is received and the flags aren't been set "1". (See detail reset methods in 5.1.1)

Response

The values of the response represent the current state of the request's receiver and may also be used by the issuer of the indication request to synchronize its remote status.

Byte	Format	Description
0	uint8_t	Device status (without cold start and configuration changed flags)
1	uint8_t	Extended device status
2	uint8_t	Standardized status 3
3-4	uint16_t	Configuration changed counter
5	uint8_t	Configuration changed and cold start flags

Response Code

Code	Class	Description
0	Success	No command-specific errors. Field device synchronized to the status indicated.
1-5		Undefined
6	Error	Device specific command error
7-127	uint16_t	Undefined



B.2 HART Command #64519: WirelessHART Connection Indication

Whenever the wireless operation mode of the M1100S changes it sends an indication to the instrument board. This information can be used to display the wireless operation mode or change the mode of operation of the instrument board.

Request

Byte	Format	Description
0	uint8_t	Wireless operation mode (see HCF common table 51)

Response

Byte	Format	Description
0	uint8_t	Wireless operation mode (see HCF common table 51)

Response Code

Code	Class	Description
0	Success	No command-specific errors
1-127		Undefined

B.3 HART Command #64520: Status Change Indication (Instrument Board to M1100S)

Request

Byte	Format	Description
0	uint8_t	Device status (without cold start and configuration changed flags)
1	uint8_t	Extended device status
2	uint8_t	Standardized status 3
3-4	uint16_t	Configuration changed counter
5	uint8_t	Configuration changed and cold start flags - 0x01 cold start - 0x02 configuration changed The flags contained in this field shall only be triggered once when a particular event occurs. They are used to set the according master flags on the other side.

Response

The values of the response represent the current state of the request's receiver and may also be used by the issuer of the indication request to synchronize its remote status.

Byte	Format	Description
0	uint8_t	Device status (without cold start and configuration changed flags)
1	uint8_t	Extended device status
2	uint8_t	Standardized status 3
3-4	uint16_t	Configuration changed counter



5	uint8_t	Configuration changed and cold start flags
---	---------	--

Response Code

Code	Class	Description
0	Success	No command-specific errors. Field device synchronized to the status indicated.
1-5		Undefined



YOUR FIELDBUS EXPERT

CONTACT INFORMATION

**Address: 17-8 Wensu Street, Hunnan New District, Shenyang,
China**

Website: www.microcyber-fieldbus.com

Phone: +86-24-31217278/+86-24-31217280

Fax: +86-24-31217338

Email: guo.ruibing@microcyber.cn